



TYPES / MODELS

RUNNER PLUS

38/42/52/58

220-240v / 50-60Hz

110-130v / 50-60Hz

230V 200Hz

- (E) Manual del Operador
- (GB) Operators Manual
- (F) Manuel De L'Opérateur
- (S) Bruksanvisning
- (PL) Instrukcja Obsługi
- (RUS) Руководство для оператора
- (LT) Naudojimo Instrukcija
- (RO) Manual de Utilizare
- (NO) Betjene Håndbok
- (CZ) Na'vod K Obzluze
- (D) Bedienungshandbuch
- (BG) Оператор Ръчен



RPLUS13/01



* MEDIO AMBIENTE * ENVIRONMENT * ENVIRONNEMENT * MILJÖ *
ŚRODOWISKO * ОКРУЖАЮЩЕЙ СРЕДЫ * APLINKA * MEDIU * MILJØ * ZIVOTNI
PROSTREDI * UMWELTSCHUTZ * ОКОЛНАТА СРЕДА *

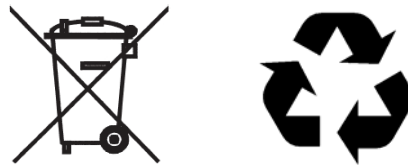

* SEGURIDAD GENERAL * GENERAL SAFETY * GENERALE DE SECURITE *
* ALLMÄN SÄKERHET * BEZPIECZEŃSTWA * ОБЩАЯ БЕЗОПАСНОСТЬ
* BENDROSIOS SAUGOS * SIGURANTA * GENERELL SIKKERHET * OBECNE
BEZPECNOSTNI POKYNY * ALLGEMEINE SICHERHEIT * ОБЩИ БЕЗОПАСНОСТ *



* AREA DE TRABAJO * WORK AREA * ZONE DE TRAVAIL *
ARBETSOMRADE * OBSZAR ROBOCZY * РАБОЧЕЕ МЕСТО * DARBO
VIETA * ZONA DE LUCRU * ARBEIDSOMRADE * PRACOVISTE *
ARBEITSUMFELD * РАБОТНОТО МЯСТО *



* QUICK VIEW *



CONVERTIDOR ELECTRONICO
Electronic drive

PULSADOR
Switch

MANGUERA CAUCHO
Rubber hose

CLAVIJA CONEXION
Connection Plug

BOTELLA VIBRADOR
Poker head vibrator

* OPERATIVA * OPERATION * FONCTIONNEMENT * DRIFT
 * PRACA URZADZENIA * РАБОЧИЕ * NAUDOJIMAS * UTILIZAREA * BRUK
 * POKYNY PRO PROVOZ * HANDHABUNG * ОПЕРАТИВНА *



1

1ph. 220-240V/50-60Hz
 1ph. 110-130V/50-60Hz

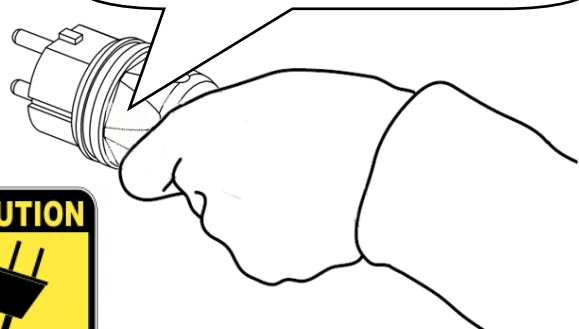

2



3

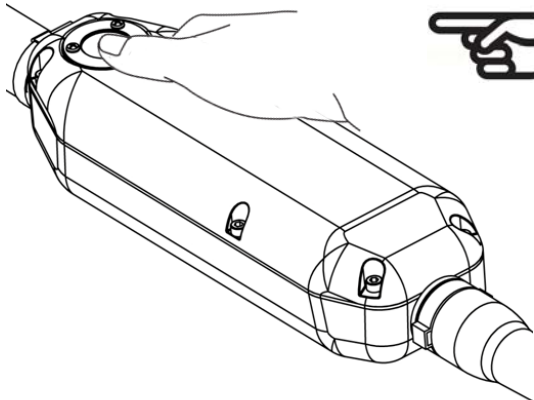

4

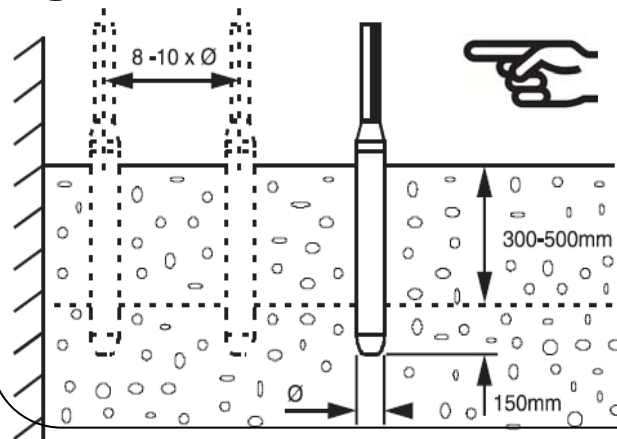

RESETEAR DESPUES DE PARADA
 RESET AFTER SHUTDOWN
 RESET après l'arrêt
 RESET efter avstängning
 RESET po wyłączeniu
 RESET после выключения
 RESET, po išjungimo
 RESET după închiderea
 RESET etter nedleggelse
 RESET po odstavení
 RESET nach dem Herunterfahren
 RESET след изключване



1

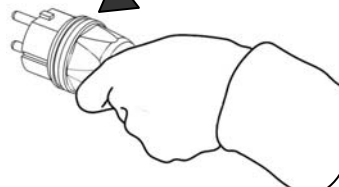

2



1' ~ 3'

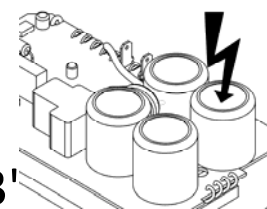

3



4

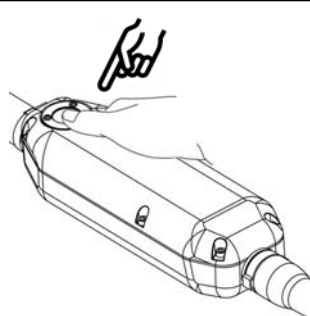

* SEGURIDAD ELECTRICA * ELECTRICAL SAFETY * SECURITE ELECTRIQUE *
 ELEKTRISK SAKERHET * BEZPIECZENSTWO ELEKTRYCZNE *
 ЭЛЕКТРИЧЕСКАЯ БЕЗОПАСНОСТЬ * DARBO SU ELEKTRINIAIS *
 SIGURANTA ELECTRIC * ELEKTRISK SIKKERHET * ELEKTRICKYM NARADIM
 * ELEKTRISCHE SICHERHEIT * ЕЛЕКТРИЧЕСКА БЕЗОПАСНОСТ *

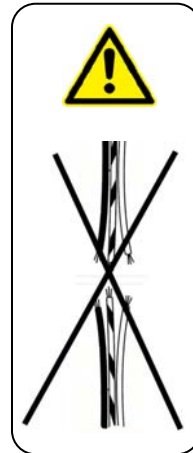
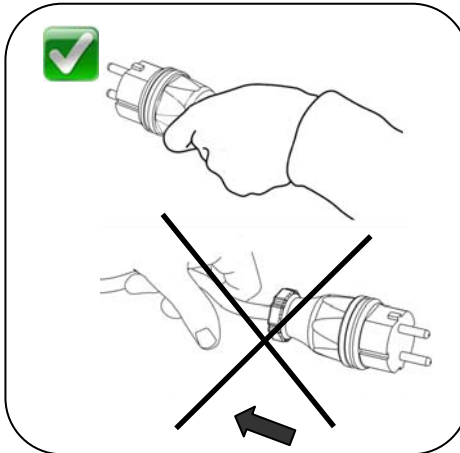
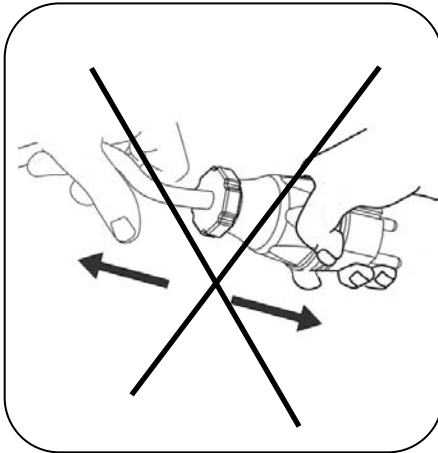

CAUTION!! - The Manufacturer declines all responsibility for any injury or damage suffered by the user, if the machine is not connected to a power supply that meets all electrical safety regulations.

EXTENSION CABLES

Poker range (Ø) Machine	Voltage	Extension (M)	Cross-section (mm ²)
Ø38/Ø42	3Ph x 42V	≤ 30	2,5
		≤ 45	4
Ø52	3Ph x 42V	≤ 20	2,5
		≤ 30	4
		≤ 45	6
Ø58	3Ph x 42V	≤ 10	2,5
		≤ 15	4
		≤ 25	6
		≤ 40	10
Ø65/Ø75	3Ph x 42V	≤ 12	4
		≤ 20	6
		≤ 30	10

*Precaución: Red con toma tierra

*Warning: Grounding electrical network

*Attention: Réseau électrique à la terre

*Varning: Elnätet elektrisk jordning

*Uwaga: Sieć elektryczna uziemienia

*Внимание: сети электрического заземления

*Atsargiai: Maitinimo elektros įžeminimo

*Atenție: Rețea de împământare electrică

*Advarsel: Stikkontakt grunnstøting

*Upozornění: Napájecí elektrické uzemnění

*Achtung: Netz elektrischen Erdung

*Внимание: електрическата мрежа
електрически заземяване



CONNECTION & PROTECTION

POKER HEAD PROTECTION



Main Supply
 Power unit (Generator)
 220-240v / 50-60Hz
 110-130v / 50-60Hz



* SERVICIO Y MANTENIMIENTO * SERVICE AND MAINTENANCE * ENTRETIEN ET REVISION * SERVICE & UNDERHALL * SERWIS I KONSERWACJA * СЕРВИС И ОБСЛУЖИВАНИЕ * TECHNINE PRIEZIURA * SERVICE SI INTRETINERE * SERVICE OG VEDLIKEHOLD * SERVIS A UDRZBA * SERVICE AND WARTUNG * ОБСЛУЖВАНЕ И ПОДДЪРЖАНЕ *



grasa sintetica*synthetic grease*graisse synthétique*Syntetiskt fett*smaru syntetycznego*синтетическая смазка*sintetinis tepalas*sintetic unsoare*syntetiske fett*syntetický mazací tuk*synthetisches Fett*синтетични мазнини

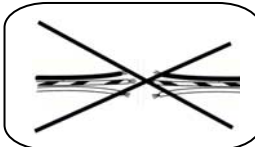
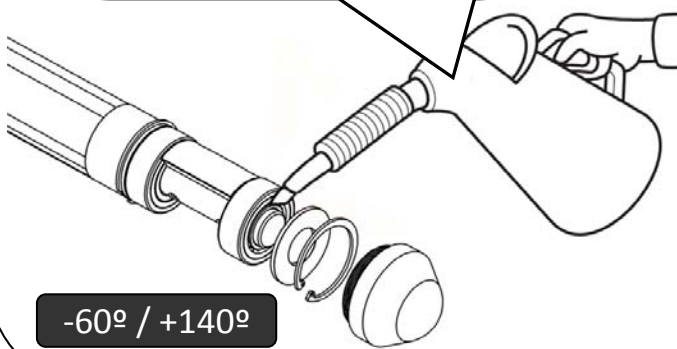

CHECK

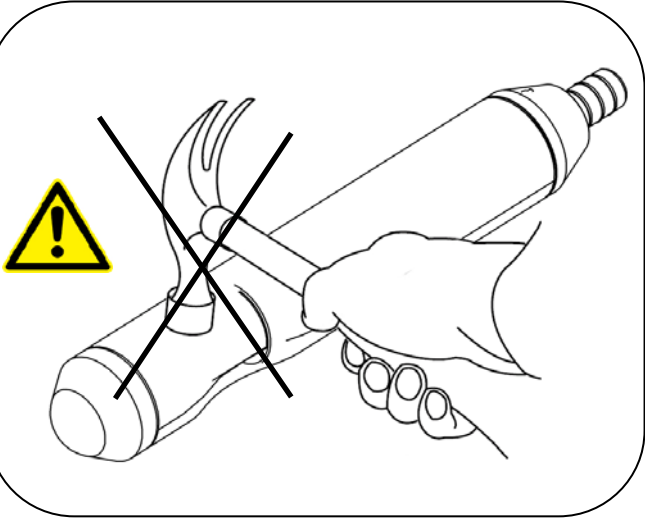

CHECK

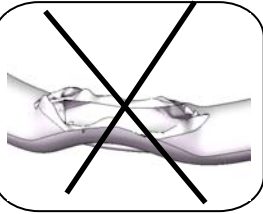

LED LIGHTING DIAGNOSTIC INFORMATION

	FIXED BLUE (READY/STANDBY)
	FLASHING BLUE (WORKING)
	FIXED RED (SHORT CIRCUIT)
	FLASHING RED (TENSION)
	FIXED RED + BLUE (OVERHEATING)